

PRODUCT DIMENSIONS

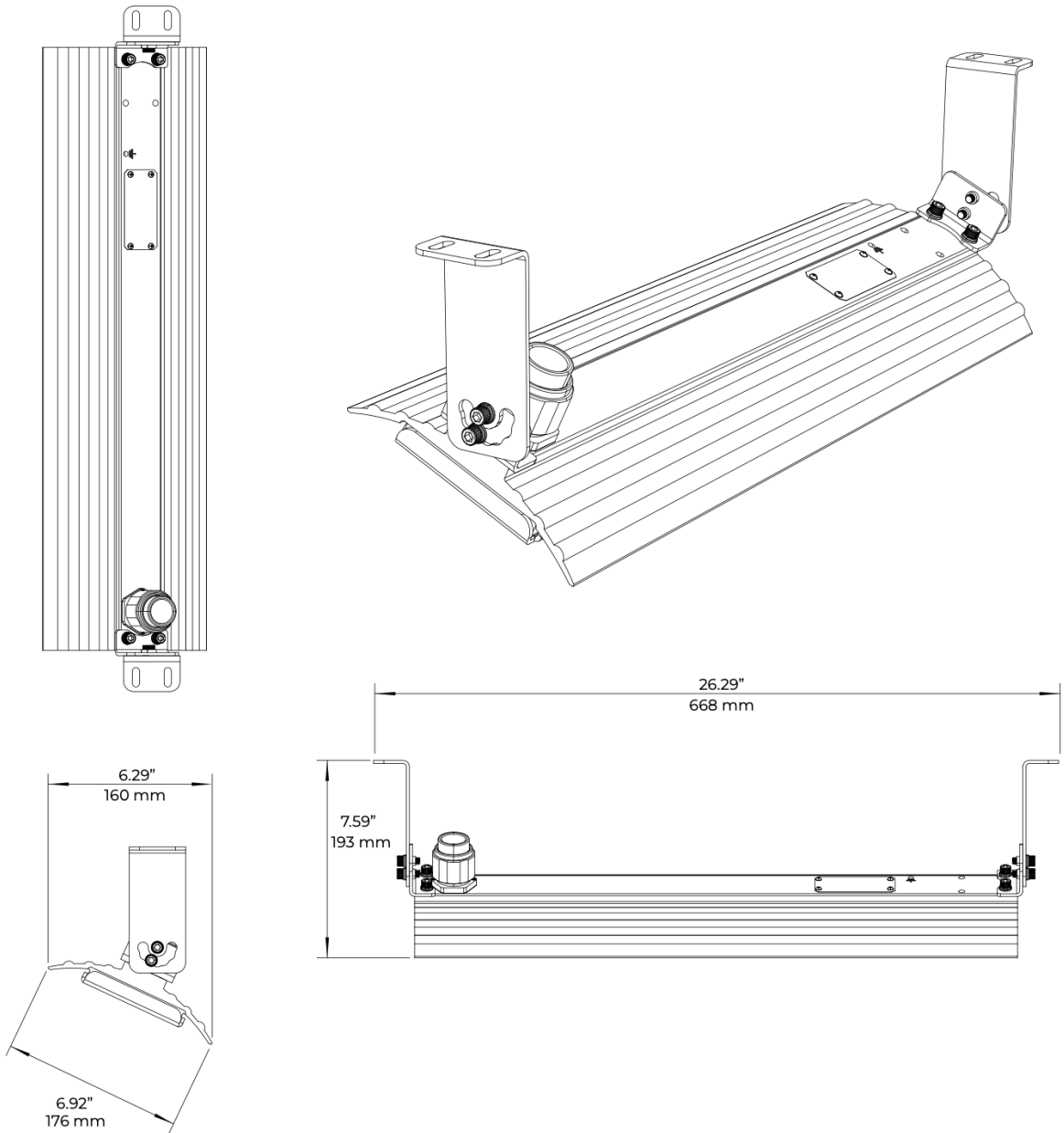

SPECIFICATIONS

PRODUCT NAME:	BE-EXP-1319C-2FT
PART NUMBER:	BE-EXP-1319C-2FT-WHT
WEIGHT:	13.10 Lbs (5.94 Kgs)
DIMENSIONS:	26.29"x6.29"x7.59" (668mm x176mm x193mm)
OPTIONS:	Adjustable Wall/Hanging Bracket

LED[®] **RUGGED PRODUCTS**
IN ACTION **FOR HARSH ENVIRONMENTS**